

Disc-Type EMIFIL® (A miniature three-terminal capacitor)
DSS6N□□□□□□□□□□ Reference Specification

1.Scope

This reference specification applies to DSS6N series.

2.Part Numbering

(Ex.)

DS	S	6	N	B3	2A	271	Q93	A
①	②	③	④	⑤	⑥	⑦	⑧	⑨

- ① Product ID (Disc-Type EMIFIL®)
- ② Structure S : Built-in Ferrite Beads Type
- ③ Style
- ④ Features
- ⑤ Temperature Characteristics
- ⑥ Rated Voltage
- ⑦ Capacitance □□□

↓
Marked three digits system.(Ex. 270pF→271)

⑧ Lead Type

Q5□ / T□1 : Bulk (in mm)

	Long Lead Type	Short Lead Type	
Straight Lead Type	Q55	Q56	Q54
Incrimp Lead Type	T51	—	T41
Lead Length(l)	25.0 min.	6.0±1.0	4.0±0.5

Lead Length (l) : See item 9.

Q9□ / U□1 : Taping (in mm)

Straight Lead Type	Q91	Q92	Q93
Incrimp Lead Type	—	U21	U31
Dimension H	20.0±1.0	16.5±1.0	18.5±1.0

Dimension H : See item 9.

⑨ Packaging Code A : Ammo Pack / B : Bulk

3.Rating

- Operating temperature : -25 to +85°C
- Storage Temperature : -25 to +85°C
- Insulation Resistance : 5000MΩ min. (DSS6NB3 / DSS6NE3 /DSS6NZ8)
- Rated Current : 6A(DC)
- Equivalent Circuit :

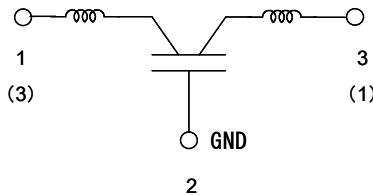

Others : See Table 1

Table 1

Customer Part Number	Murata Part Number	Temperature Characteristics	Capacitance	Rated Voltage	Withstanding Voltage	Unit Mass (Typical value)
	DSS6NB32A220Q55B	±10%	22pF± 20%	100V(DC)	250 V(DC)	0.43g
	DSS6NB32A220Q56B					0.43g
	DSS6NB32A220Q54B					0.43g
	DSS6NB32A220T51B					0.47g
	DSS6NB32A220T41B					0.47g
	DSS6NB32A220Q91A					0.43g
	DSS6NB32A220Q92A					0.43g
	DSS6NB32A220Q93A					0.43g
	DSS6NB32A220U21A					0.43g
	DSS6NB32A220U31A					0.43g

Customer Part Number	Murata Part Number	Temperature Characteristics	Capacitance	Rated Voltage	Withstanding Voltage	Unit Mass (Typical value)	
	DSS6NB32A330Q55B	±10%	33pF± 20%	100V(DC)	250 V(DC)	0.43g	
	DSS6NB32A330Q56B					0.43g	
	DSS6NB32A330Q54B					0.43g	
	DSS6NB32A330T51B					0.47g	
	DSS6NB32A330T41B					0.47g	
	DSS6NB32A330Q91A					0.43g	
	DSS6NB32A330Q92A					0.43g	
	DSS6NB32A330Q93A					0.43g	
	DSS6NB32A330U21A					0.43g	
	DSS6NB32A330U31A					0.43g	
	DSS6NB32A470Q55B					47pF± 20%	0.42g
	DSS6NB32A470Q56B						0.42g
	DSS6NB32A470Q54B		0.42g				
	DSS6NB32A470T51B		0.46g				
	DSS6NB32A470T41B		0.46g				
	DSS6NB32A470Q91A		0.42g				
	DSS6NB32A470Q92A		0.42g				
	DSS6NB32A470Q93A		0.42g				
	DSS6NB32A470U21A		0.42g				
	DSS6NB32A470U31A		0.42g				
	DSS6NB32A101Q55B		100pF± 20%				0.42g
	DSS6NB32A101Q56B						0.42g
	DSS6NB32A101Q54B					0.42g	
	DSS6NB32A101T51B					0.46g	
	DSS6NB32A101T41B					0.46g	
	DSS6NB32A101Q91A					0.42g	
	DSS6NB32A101Q92A					0.42g	
	DSS6NB32A101Q93A					0.42g	
	DSS6NB32A101U21A					0.42g	
	DSS6NB32A101U31A					0.42g	
	DSS6NB32A151Q55B					150pF± 20%	0.42g
	DSS6NB32A151Q56B						0.42g
	DSS6NB32A151Q54B		0.42g				
	DSS6NB32A151T51B		0.46g				
	DSS6NB32A151T41B		0.46g				
	DSS6NB32A151Q91A		0.42g				
	DSS6NB32A151Q92A	0.42g					
	DSS6NB32A151Q93A	0.42g					
	DSS6NB32A151U21A	0.42g					
	DSS6NB32A151U31A	0.42g					
	DSS6NB32A221Q55B	220pF± 20%	0.42g				
	DSS6NB32A221Q56B		0.42g				
	DSS6NB32A221Q54B		0.42g				
	DSS6NB32A221T51B		0.46g				
	DSS6NB32A221T41B		0.46g				
	DSS6NB32A221Q91A		0.42g				
	DSS6NB32A221Q92A		0.42g				
	DSS6NB32A221Q93A		0.42g				
	DSS6NB32A221U21A		0.42g				
	DSS6NB32A221U31A		0.42g				

Customer Part Number	Murata Part Number	Temperature Characteristics	Capacitance	Rated Voltage	Withstanding Voltage	Unit Mass (Typical value)
	DSS6NB32A271Q55B	±10%	270pF± 20%	100V(DC)	250 V(DC)	0.42g
	DSS6NB32A271Q56B					0.42g
	DSS6NB32A271Q54B					0.42g
	DSS6NB32A271T51B					0.46g
	DSS6NB32A271T41B					0.46g
	DSS6NB32A271Q91A					0.42g
	DSS6NB32A271Q92A					0.42g
	DSS6NB32A271Q93A					0.42g
	DSS6NB32A271U21A					0.42g
	DSS6NB32A271U31A		0.42g			
	DSS6NB32A471Q55B		470pF± 20%			0.43g
	DSS6NB32A471Q56B					0.43g
	DSS6NB32A471Q54B					0.43g
	DSS6NB32A471T51B					0.47g
	DSS6NB32A471T41B					0.47g
	DSS6NB32A471Q91A					0.43g
	DSS6NB32A471Q92A					0.43g
	DSS6NB32A471Q93A					0.43g
	DSS6NB32A471U21A					0.43g
	DSS6NB32A471U31A	0.43g				
	DSS6NB32A102Q55B	1000pF± 20%	0.42g			
	DSS6NB32A102Q56B		0.42g			
	DSS6NB32A102Q54B		0.42g			
	DSS6NB32A102T51B		0.46g			
	DSS6NB32A102T41B		0.46g			
	DSS6NB32A102Q91A		0.42g			
	DSS6NB32A102Q92A		0.42g			
	DSS6NB32A102Q93A		0.42g			
	DSS6NB32A102U21A		0.42g			
	DSS6NB32A102U31A		0.42g			
	DSS6NE32A222Q55B		± ₂₀ ⁵⁵ %	2200pF± ₈₀ ²⁰ %	0.42g	
	DSS6NE32A222Q56B	0.42g				
	DSS6NE32A222Q54B	0.42g				
	DSS6NE32A222T51B	0.46g				
	DSS6NE32A222T41B	0.46g				
	DSS6NE32A222Q91A	0.42g				
	DSS6NE32A222Q92A	0.42g				
	DSS6NE32A222Q93A	0.42g				
	DSS6NE32A222U21A	0.42g				
	DSS6NE32A222U31A	0.42g				
	DSS6NZ82A103Q55B	± ₃₀ ⁸⁵ %	10000pF± 30 %	0.42g		
	DSS6NZ82A103Q56B			0.42g		
	DSS6NZ82A103Q54B			0.42g		
	DSS6NZ82A103T51B			0.46g		
	DSS6NZ82A103T41B			0.46g		
	DSS6NZ82A103Q91A			0.42g		
	DSS6NZ82A103Q92A			0.42g		
	DSS6NZ82A103Q93A			0.42g		
	DSS6NZ82A103U21A			0.42g		
	DSS6NZ82A103U31A	0.42g				

4. Testing Conditions

<Unless otherwise specified>
 Temperature : Ordinary Temperature 15 to 35°C
 Humidity : Ordinary Humidity 25 to 85 %(RH)

<In case of doubt>
 Temperature : 20 ± 2°C
 Humidity : 60 to 70 %(RH)
 Atmospheric Pressure : 86 to 106 kPa

5. Style and Dimension

See item 9.

6. Marking

Capacitance	Marked real number. (22pF to 47pF) Ex. 22pF→22 Marked three digits system.(100pF) Ex.1000pF→102
Rated Voltage	Marked voltage value.(100V)
Trade Mark	Marked as 

7. Performance

No.	Item	Specification	Test Method												
7.1	Appearance and Dimensions	Meet item 9.	Visual Inspection and measured with Slide Calipers.												
7.2	Marking	Marking is able to be read easily.	Visual Inspection.												
7.3	Capacitance and Tolerance	Meet item 3.	<p><u>Table 2</u></p> <table border="1"> <thead> <tr> <th>Frequency</th> <th>Test Voltage</th> <th>Capacitance</th> </tr> </thead> <tbody> <tr> <td>1±0.1MHz</td> <td>3 V(rms) max.</td> <td>22pF~100pF</td> </tr> <tr> <td>1±0.1kHz</td> <td>3 V(rms) max.</td> <td>150pF~10000pF</td> </tr> </tbody> </table>	Frequency	Test Voltage	Capacitance	1±0.1MHz	3 V(rms) max.	22pF~100pF	1±0.1kHz	3 V(rms) max.	150pF~10000pF			
Frequency	Test Voltage	Capacitance													
1±0.1MHz	3 V(rms) max.	22pF~100pF													
1±0.1kHz	3 V(rms) max.	150pF~10000pF													
7.4	Insulation Resistance(I.R.)	Meet item 3.	Test Voltage : Rated Voltage Time : 1 minute through a suitable resistor 1MΩ.												
7.5	Withstanding Voltage	Products shall not be damaged.	Test Voltage : 2.5 times for Rated Voltage Time : 1 to 5 seconds Charge Current : 10 mA max. It shall be applied between input / output terminal and ground terminal.												
7.6	Temperature Characteristics	Meet item 3.	<p>Capacitance shall be measured at each step specified in Table 3 after reaching the thermal equilibrium. The capacitance change against the capacitance at step 3 shall be calculated. () is for DSS6NZ82A103.</p> <p><u>Table3</u></p> <table border="1"> <thead> <tr> <th>Step</th> <th>1</th> <th>2</th> <th>3</th> <th>4</th> <th>5</th> </tr> </thead> <tbody> <tr> <td>Temp. (°C)</td> <td>+20±2</td> <td>-25±2 (-10)</td> <td>+20±2</td> <td>+85±2 (60)</td> <td>+20±2</td> </tr> </tbody> </table>	Step	1	2	3	4	5	Temp. (°C)	+20±2	-25±2 (-10)	+20±2	+85±2 (60)	+20±2
Step	1	2	3	4	5										
Temp. (°C)	+20±2	-25±2 (-10)	+20±2	+85±2 (60)	+20±2										
7.7	Solderability	Along the circumference of terminal shall be covered with new solder at least 75%.	<p>Flux : Ethanol solution of rosin,25(wt)% (dipped for 5 to 10 seconds) Pre-heat : 150±10°C, 60~90 s Solder : Sn-3.0Ag-0.5Cu Solder Temperature 245±5°C Immersion Time : 2 ± 0.5 seconds Immersion Depth : 2 to 2.5 mm from the bottom of the body.</p>												

No.	Item	Specification	Test Method													
7.8	Resistance to Soldering Heat	Meet Table 4. <u>Table 4</u> <table border="1"> <tr> <td>Appearance</td> <td colspan="2">No damaged.</td> </tr> <tr> <td rowspan="3">Capacitance Change</td> <td>B3</td> <td>within $\pm 5\%$</td> </tr> <tr> <td>E3</td> <td>within $\pm 15\%$</td> </tr> <tr> <td>Z8</td> <td>within $\pm 20\%$</td> </tr> <tr> <td>Withstanding Voltage</td> <td colspan="2">No damaged.</td> </tr> </table>	Appearance	No damaged.		Capacitance Change	B3	within $\pm 5\%$	E3	within $\pm 15\%$	Z8	within $\pm 20\%$	Withstanding Voltage	No damaged.		Flux : Ethanol solution of rosin,25(wt)% (dipped for 5 to 10 seconds) Pre-heat : $150 \pm 10^\circ\text{C}$, 60~90 s Solder : Sn-3.0Ag-0.5Cu Solder Temperature : $270 \pm 5^\circ\text{C}$ Immersion Time : 3 ± 0.5 seconds Immersion Depth : 1.6 ± 0.7 mm from the bottom of the body. Then measured after exposure in the room condition for 4 to 24hours.
Appearance	No damaged.															
Capacitance Change	B3	within $\pm 5\%$														
	E3	within $\pm 15\%$														
	Z8	within $\pm 20\%$														
Withstanding Voltage	No damaged.															
7.9	Humidity	Meet Table 5. <u>Table 5</u> <table border="1"> <tr> <td>Appearance</td> <td colspan="2">No damaged.</td> </tr> <tr> <td rowspan="3">Capacitance Change</td> <td>B3</td> <td>within $\pm 10\%$</td> </tr> <tr> <td>E3,</td> <td>within $\pm 20\%$</td> </tr> <tr> <td>Z8</td> <td>within $\pm 30\%$</td> </tr> <tr> <td>Insulation Resistance</td> <td>B3,E3 Z8</td> <td>1000MΩ min.</td> </tr> </table>	Appearance	No damaged.		Capacitance Change	B3	within $\pm 10\%$	E3,	within $\pm 20\%$	Z8	within $\pm 30\%$	Insulation Resistance	B3,E3 Z8	1000M Ω min.	Temperature : $40 \pm 2^\circ\text{C}$ Humidity : 90 to 95 %(RH) Time : 500 hours(+24-0 hours) Then measured after exposure in the room condition for 4 to 24hours.
Appearance	No damaged.															
Capacitance Change	B3	within $\pm 10\%$														
	E3,	within $\pm 20\%$														
	Z8	within $\pm 30\%$														
Insulation Resistance	B3,E3 Z8	1000M Ω min.														
7.10	Humidity Life	Meet Table6. <u>Table 6</u> <table border="1"> <tr> <td>Appearance</td> <td colspan="2">No damaged.</td> </tr> <tr> <td rowspan="3">Capacitance Change</td> <td>B3</td> <td>within $\pm 10\%$</td> </tr> <tr> <td>E3</td> <td>within $\pm 20\%$</td> </tr> <tr> <td>Z8</td> <td>within $\pm 30\%$</td> </tr> <tr> <td>Insulation Resistance</td> <td>B3,E3 Z8</td> <td>500MΩ min.</td> </tr> </table>	Appearance	No damaged.		Capacitance Change	B3	within $\pm 10\%$	E3	within $\pm 20\%$	Z8	within $\pm 30\%$	Insulation Resistance	B3,E3 Z8	500M Ω min.	Temperature : $40 \pm 2^\circ\text{C}$ Humidity : 90 to 95 %(RH) Time : 500 hours(+24-0 hours) Applying Voltage : Rated Voltage Charge Current : 10 mA max. Then measured after exposure in the room condition for 4 to 24hours.
Appearance	No damaged.															
Capacitance Change	B3	within $\pm 10\%$														
	E3	within $\pm 20\%$														
	Z8	within $\pm 30\%$														
Insulation Resistance	B3,E3 Z8	500M Ω min.														
7.11	Heat Life	Meet Table 7. <u>Table 7</u> <table border="1"> <tr> <td>Appearance</td> <td colspan="2">No damaged.</td> </tr> <tr> <td rowspan="3">Capacitance Change</td> <td>B3</td> <td>within $\pm 10\%$</td> </tr> <tr> <td>E3</td> <td>within $\pm 20\%$</td> </tr> <tr> <td>Z8</td> <td>within $\pm 30\%$</td> </tr> <tr> <td>Insulation Resistance</td> <td>B3,E3 Z8</td> <td>1000MΩ min.</td> </tr> </table>	Appearance	No damaged.		Capacitance Change	B3	within $\pm 10\%$	E3	within $\pm 20\%$	Z8	within $\pm 30\%$	Insulation Resistance	B3,E3 Z8	1000M Ω min.	Temperature : $85 \pm 3^\circ\text{C}$ Time : 1000 hours(+48-0 hours) Applying Voltage : B3,E3 character : 2 times of DC rated voltage Z8 character : 1.5times of DC rated voltage Charge Current : 10 mA max. Then measured after exposure in the room condition for 4 to 24hours.
Appearance	No damaged.															
Capacitance Change	B3	within $\pm 10\%$														
	E3	within $\pm 20\%$														
	Z8	within $\pm 30\%$														
Insulation Resistance	B3,E3 Z8	1000M Ω min.														

8. Mounting Hole

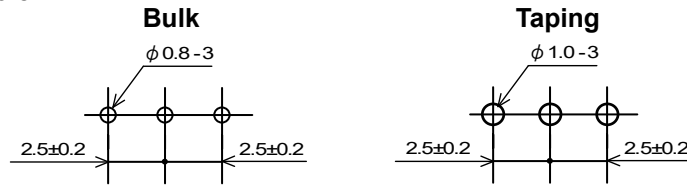

9. Style and Dimension

(1) Bulk (Straight Lead Type) : Q5□

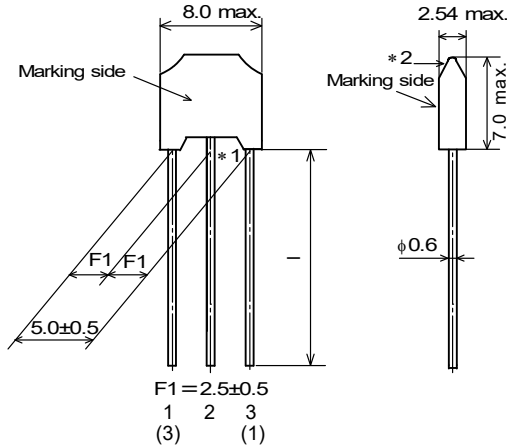

- *1. Bottom of dielectric may be exposed.
- *2. There should not be the exposure of the ferrite bead if a hole is on the top of ferrite bead.

Lead Type	l
Q55	25.0 min.
Q56	6.0±1.0
Q54	4.0±0.5

(in mm)

(2) Bulk (Incrimp Lead Type) : T□1

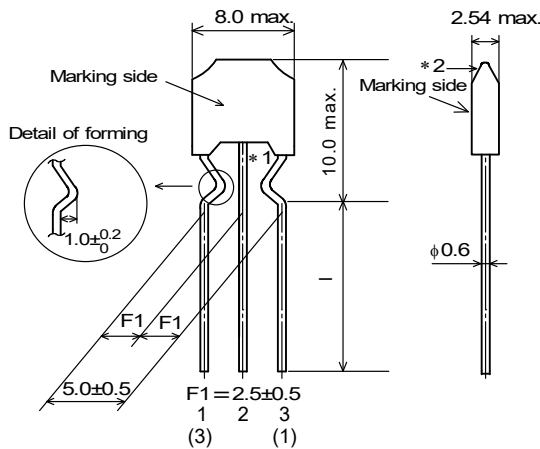

- *1. Bottom of dielectric may be exposed.
- *2. There should not be the exposure of the ferrite bead if a hole is on the top of ferrite bead.

Lead Type	l
T51	25.0 min.
T41	4.0±0.5

(in mm)

(3) Taping (Straight Lead Type) : Q9□

(All symbols in the illustrations below are described in Table 8)

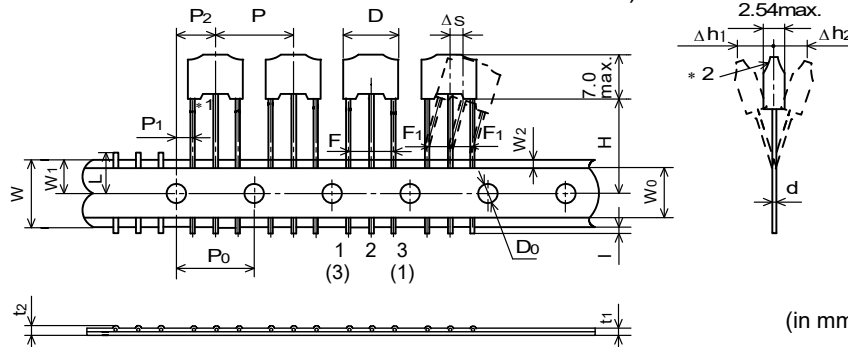

- *1. Bottom of dielectric may be exposed.
- *2. There should not be the exposure of the ferrite bead if a hole is on the top of ferrite bead.

(4) Taping (Incrimp Lead Type) : U□1

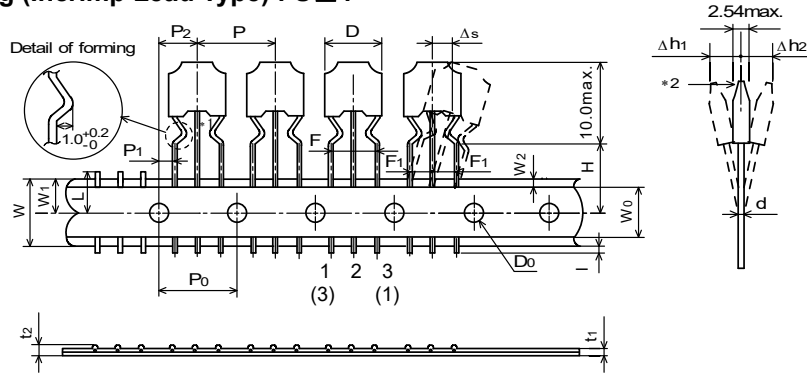

*1. Bottom of dielectric may be exposed.

*2. There should not be the exposure of the ferrite bead if a hole is on the top of ferrite bead.

Table 8

Code	Description	Dimensions	Remark
P	Pitch of Component	12.7	Product Inclination ΔS Determines Crossing
P0	Pitch of Sprocket Hole	12.7±0.2	
P1	Length from Hole Center to Lead	3.75±0.7	
P2	Length from Hole Center to Component Center	6.35±1.3	Shift In Tape In Direction of Feed
D	Width of Body	7.0 max.	
ΔS	Deviation along tape, Left or Right	0±1.0	
W	Carrier Tape Width	17.0±0.5	
W1	Position of Sprocket Hole	9.0+0,-0.5	Tape Widthwise Shift
l	Protrusion Length	+0.5 ~ -1.0	
D0	Diameter of Sprocket Hole	φ 4.0±0.1	
d	Lead Diameter	φ 0.6	
t1	Total Tape Thickness	0.7±0.2	Includes Thickness of Bonding Tape
t2	Total Thickness, Tape and Lead Wire	1.5 max.	
Δh1	Deviation across Tape, front	1.0 max.	
Δh2	Deviation across Tape, rear	1.0 max.	
L	Portion to Cut in Case of Defect	11.0+0,-1.0	
W0	Hold Down Tape Width	12.0±0.5	
W2	Hold Down Tape Position	1.5±1.5	
H	Lead length between sprocket hole and forming position	Q91	20.0±1.0
		Q92 U21	16.5±1.0
		Q93 U31	18.5±1.0
F	Lead Spacing	5.0+0.7,-0.2	
F1		2.5+0.4,-0.2	

(in mm)

10. Taping

10.1 Supplement condition of taping

- (1) A maximum of 0.3% of the components quantity per reel or Ammo pack may be missing without consecutive missing components.
- (2) The adhesive power of the tape shall have over 2.94N at the following condition.

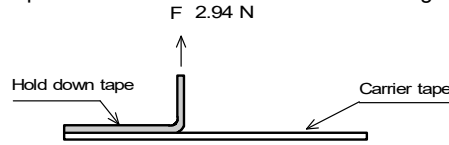

(3) Splicing method of tape

1. Carrier tape

Carrier tape shall be spliced by cellophane tape.
Overall thickness shall be less than 1.05 mm.

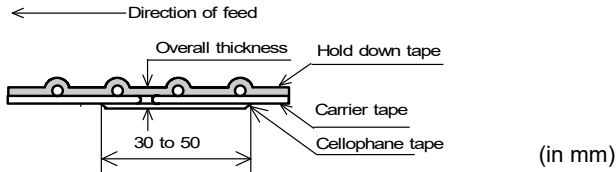

2. Hold down tape

Hold down tape shall be spliced with overlapping.
Overall thickness shall be less than 1.05 mm.

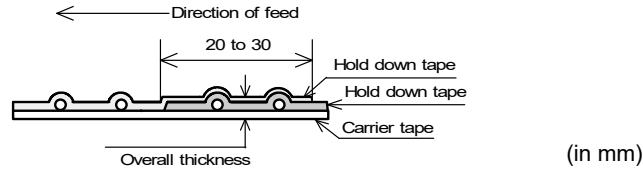

3. Both carrier tape and hold down tape

Both tapes shall be cut zigzag and spliced with splicing tape.

11. Packing

11.1 Packing quantity

The standard packing quantity is as follows.

(The packing quantity may be changed due to a fraction of order.)

Minimum Packing Form and Quantity

Terminal Configuration		A Unit Quantity Bulk : in a plastic bag Taping : in an ammo pack	* Standard Quantity in a container (corrugated cardboard box)
Bulk	Long Lead Type (Q55/T51)	250 pcs.	5000 pcs.
	Short Lead Type (Q54/Q56/T41)	500 pcs.	10000 pcs.
Taping (Q91/ Q92/ Q93/U21/U31)		2000 pcs.	20000 pcs.

* A quantity in a container is depending on a quantity of an order.

11.2 Packing Form

(1) Bulk

<A plastic bag pack>

1. Products are packed into a plastic bag.

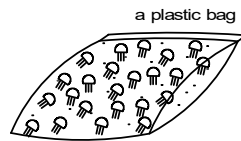

2. The plastic bags are put into a container (corrugated cardboard box) depending on a quantity of an order.

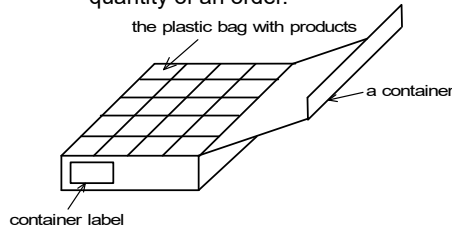

(2) Taping

<An ammo pack>

1. Folding the tape per 25 pitches, products are packed into an ammo package so that each product of each layer wound zigzag is put on top of one another. [Fig 1]
2. The dimensions of the ammo package are indicated in [Fig 2].
3. The ammo packages are put into a container (corrugated cardboard box) depending on a quantity of an order.
4. Not less than 3 consecutive of component shall be missing on both edge of tape.

[Fig 1] zig zag

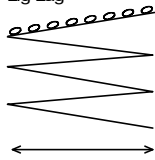

The unloading direction : Right

The hold down tape : Upper

The product body : Left along the unloading direction

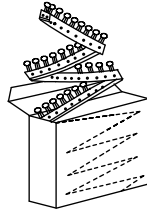

[Fig 2]

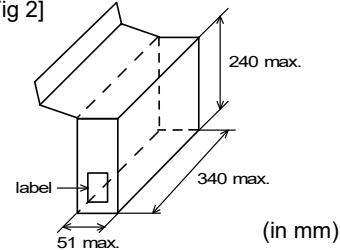

(in mm)

12. Marking on package**12.1 Unit Package**

Bulk : Marked on a plastic bag.

Taping : Marked on a label stuck on an ammo package.

Marking on a unit package consists of :

Customer part number, MURATA part number, Inspection number(*1), RoHS marking (*2), Quantity, etc

*1) « Expression of Inspection No. »

□□	OOOO	XXX
(1)	(2)	(3)

(1) Factory Code

(2) Date

First digit : Year / Last digit of year

Second digit : Month / Jan. to Sep. → 1 to 9, Oct. to Dec. → O,N,D

Third, Fourth digit : Day

(3) Serial No.

*2) « Expression of RoHS marking »

ROHS - Y (△)

(1) RoHS regulation conformity parts.

(2) MURATA classification number

12.2 Container

Marking on the label stuck on a container consists of :

Customer name Purchasing Order Number, Customer Part Number, MURATA part number,

RoHS marking (*2), Quantity, etc

13. ⚠ Caution**13.1 Mounting holes**

Mounting holes should be designed as specified in this specifications.

Or different design from this specifications may cause cracks in ceramics which may lead to smoking / firing.

13.2 Caution for the product angle adjust work

Take care not to apply any mechanical stress to product body at the lead terminal bending process for product angle adjustment after insertion.

13.3 Limitation of Applications

Please contact us before using our products for the applications listed below which require especially high reliability for the prevention of defects which might directly cause damage to the third party's life, body or property.

- | | |
|--|--|
| (1) Aircraft equipment | (7) Traffic signal equipment |
| (2) Aerospace equipment | (7) Disaster prevention / crime prevention equipment |
| (3) Undersea equipment | (9) Data-processing equipment |
| (4) Power plant control equipment | (10) Applications of similar complexity and /or reliability requirements |
| (5) Medical equipment | to the applications listed in the above |
| (6) Transportation equipment (vehicles, trains, ships, etc.) | |

14. Notice**14.1 Soldering**

- (1) Use rosin-based flux. Do not use strong acidic flux with halide content exceeding 0.2(wt)% (chlorine conversion value).
Use Sn-3.0Ag-0.5Cu solder

- (2) Standard flow soldering profile.

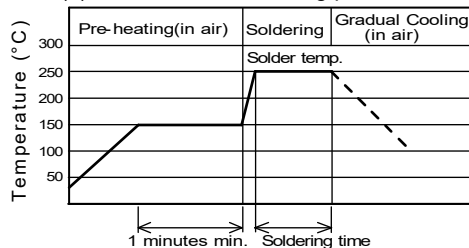

Solder temperature	Soldering time
250~260 °C	4~6s

- (3) Resistance to soldering iron goes in the following condition that tip temperature is 350 °C max. and soldering time is 5 s max.
- (4) Products and the leads should not be subjected to any mechanical stress during soldering process. (and also while subjected to the equivalent high temperature.)

14.2 Cleaning

Products shall be cleaned on following conditions.

- (1) Cleaning Temperature: 60°C max.(40°C max. for Isopropyl alcohol).
- (2) Ultrasonic cleaning shall comply with the following conditions, avoiding the resonance phenomenon at the mounted products and P.C.B.
 - Power : 20W / l max.
 - Frequency : 28kHz ~ 40kHz
 - Time : 5 minutes max.
- (3) Cleaning agent
 1. alcohol cleaning agents.
 - Isopropyl alcohol (IPA)
 2. Aqueous cleaning agent
 - Pine Alpha ST-100S
- (4) Ensure that residual flux and residual cleaning agent is completely removed.
Products should be thoroughly dried after aqueous agent has been removed with de-ionized water.
- (5) For other cleaning methods, please contact Murata engineering.

14.3 Operating Environment

- (1) Do not use products in corrosive gases such as chlorine gas, acid or sulfide gas.
- (2) Do not use products in the environment where water, oil or organic solvents may adhere to products.
- (3) Do not adhere any resin to products, coat nor mold products with any resin (including adhesive) to prevent mechanical and chemical stress on products.

14.4.Storage and handling requirements.

- (1) Storage period
 - Use the products within 12 months after delivered.
 - Solderability should be checked if this period is exceeded.
- (2) Storage environment condition
 - To prevent products quality deterioration, stored conditions should be controlled as follows ;
 1. Temperature : -10 to 40 degrees centigrade
 2. Humidity : 15 to 85% relative humidity
 3. Products should be stored without sudden changes in temperature and humidity.
Don't keep products in corrosive gases such as sulfur, chlorine gas or acid, or it may cause oxidization of lead terminals resulting in poor solderability.
 4. Products should be stored on the palette for the prevention of the influence from humidity, dust and so on.
 5. Products should be stored in the warehouse without heat shock, vibration, direct sunlight and so on.
- (3) Handling Conditions
 - Care should be taken when transporting or handling product to avoid excessive vibration or mechanical shock.

15.  **Note**

- (1) Please make sure that your product has been evaluated in view of your specifications with our product being mounted to your product.
- (2) You are requested not to use our product deviating from the reference specifications.
- (3) The contents of this reference specification are subject to change without advance notice. Please approve our product specifications or transact the approval sheet for product specifications before ordering.